

JIMNY

GEAR TO PROCLAIM



**CARVE YOUR
LEGENDARY PATH**



**ROOKIE
OF THE YEAR
2020**



**WINNER
WORLD CAR AWARDS
2019 WORLD URBAN CAR**



**TOP THREE IN THE WORLD
2019 WORLD CAR AWARDS
WORLD CAR DESIGN OF THE YEAR**



GRIDOTO AWARD 2020
The Best Resale Value
Compact SUV

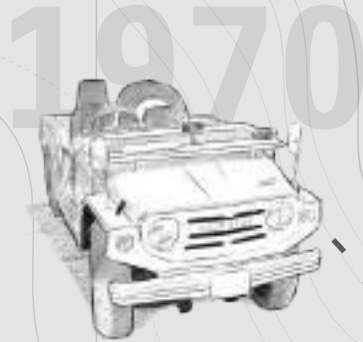

**THE 1st GENERATION 1970**

The beginning of a legacy that shattered all the rules, becoming a legend for off-road fans who crave a good thrilling adventure.

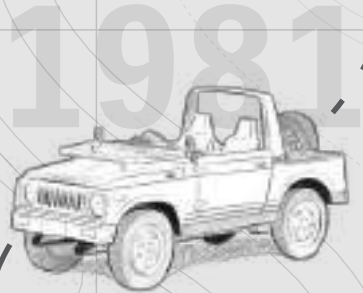
**THE 2nd GENERATION 1981**

The Second Generation Jimny still rocks the '80s with its head-turning design, both on and off the road. The legacy continues as it conquers both urban streets and untamed terrains.

**THE 3rd GENERATION 1998**

With its aerodynamic design, extended wheelbase, and improved rigid suspension, this Jimny sets a new standard. Crafted for superior comfort, the legacy persists for two decades.

**THE 4th GENERATION 2018**

The legacy evolves into its most best form, driven by a pursuit of perfection and a stylish design that elevates every adventure.

LEGACY'S FOUR-CHAPTER JOURNEY

Gaining wisdom from each adventure and its long journey, the Jimny grows more resilient on the toughest trails, showcasing growth and adaptability in every era.





So, let this legend be the accomplice
as you carve your extraordinary path ahead
and forge your remarkable journey.

**CARVE YOUR
LEGENDARY PATH**

Designed for greater adventures, this 5-door Jimny combines spaciousness with remarkable details to elevate your experience in the great outdoors.



NEW

5 SLOTS CHROME GRILLE*
 Providing an iconic legacy appearance with a timeless touch. With a sense of heritage and elegance, the chrome finish can elevate your car's exterior.



NEW

4 SPOTS PARKING SENSOR + REAR VIEW CAMERA*
 With newest technology and responsive sensors to detect any obstacle in any surrounding. For a broader point of view to enhance parking safety.



MANUAL LEVELING LED PROJECTOR HEADLAMP WITH WASHER
 These iconic Jimny's headlamps come equipped with washers, allowing you to confidently go through mud, dirt, or snow without any hesitation.

*Available for Jimny 5-door



ELEVATE YOUR CONNECTIVITY

Equipped with new generation display audio with a large 9" touchscreen* to make every drive is enhanced. With features like Vehicle Status Display, smartphone linkage, voice recognition, Bluetooth®** music playback compatible with Apple CarPlay & Android Auto



Connect your iPhone to the infotainment system wirelessly or via USB to enable hands-free telephone calls, listen to music, have texts read out, or dictate messages.



Connect your device via a USB socket to access various applications from Google without losing your focus.



*Available for Jimmy 5-door

**Bluetooth® is registered trademark of Bluetooth SIG, Inc.



Step into this bigger legacy, where the thrill of greater adventures converges with the embrace of extra space. Now just picture a larger Jimny, elevated with a longer wheelbase and two extra doors. So, climb in and out without worry, thanks to the new 5-door that provides effortless mobility.

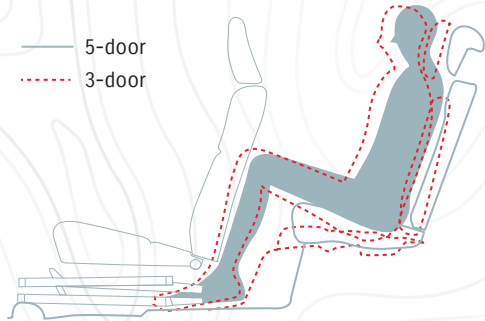

The expanded trunk ensures you to be well-prepared for spontaneous journeys into the unknown. Imagine sharing the experience with your favorite companions, each enjoying a comfortable seat on the smooth roads or challenging trails that lie ahead.

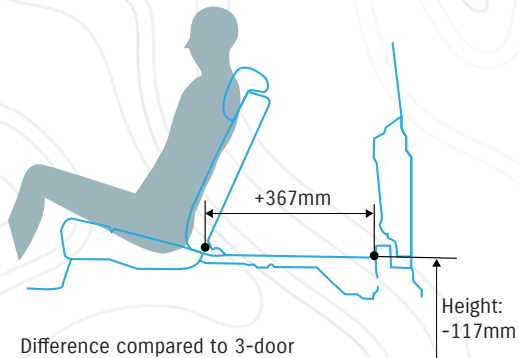

YOUR GEAR







YOUR GEAR

JIMNY

3-door

Cruise uncertainty confidently with the legacy.
In every turn and every acceleration, embrace
the thrill of the journey.



The 3-door Jimny is compact with distinctive details, making it well-suited for navigating tight on-road and off-road trails.

**OPTIMISED BUMPERS**

Avoid any obstacle ahead as the angled bumper edges increase wheel clearance. Fear not stone chips; the robust, textured black material on the bumpers can shield against any scratches.

**DARK METALLIC GRAY ALLOY WHEEL WITH TIRE 195/80 R15**

Perfect combination of style and durability, ensuring your car stands out with elegant touch of dark metallic to make a smoother driving experience.

**REAR COMBINATION LAMP**

From daylight to nighttime, it's a crucial feature for your adventure. Reducing risk of accident for safer driving.

**6.8 INCH HEAD UNIT**

The 3-door Jimny is equipped with Vehicle Status Display, USB, Bluetooth®** and Smartphone Connection features for more enjoyable journey.

**INTUITIVELY DESIGNED CONTROLS**

Designed for easy use in challenging conditions. It features switches to the dials, touchscreen controls, ensuring you stay focused on conquering the terrain.

**COMFORTABLE SEAT DESIGN**

Embrace the unforgiving terrain with seats designed for shock absorptions for exceptional and comfortable drive.





YOUR GEAR

AT



MT

ESP® (ELECTRONIC STABILITY PROGRAMME)**

Enhances braking stability on slippery and curved roads, preventing both oversteer and understeer.

PRACTICAL DRIP RAIL

The Jimny roof's drip rail on the sides and rear is flexible for installing roof carriers and keeps you dry when entering or exiting by preventing water drips.

TECT BODY

The frame structure effectively absorbs and distributes energy during bumps and crashes, ensuring the cabin space remains more intact.

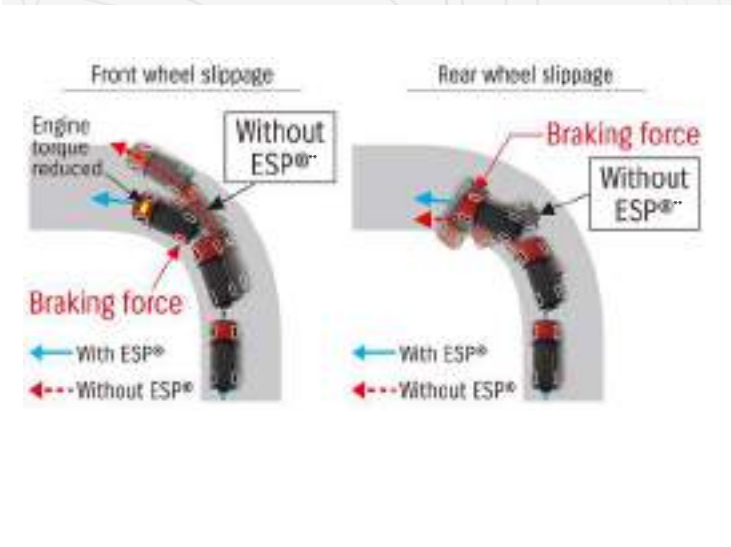



YOUR GEAR

ENGINE PERFORMANCE

The responsive 1.5L K15B engine maintains off-road driving capability, producing strong torque throughout RPM range to provide unwavering power for conquering any terrain.



ALLGRIP PRO

Whether on smooth or challenging roads, simply shift the transfer lever.

2H: For driving at normal speeds on roads (asphalt/gravel).

4H: For off-road driving.

4L: For navigating rough rocks, mud, and more challenging terrain.

LADDER FRAME CHASSIS

Built with a robust Ladder Frame structure, the Jimny guides you through rugged topographies. Paired with full-width rigid axles at the front and rear, it conquers the most challenging paths.



3-LINK RIGID AXLE SUSPENSION WITH COIL SPRING

The Jimny, with its tough 3-link suspension and rigid axles at both the front and rear, ensures stability on any terrain. The rigid axle suspension pushes one wheel up while the axle presses the other down, especially in rough road conditions.

AIRBAGS

Be extra prepared to navigate uncertainties with the six airbags for 5-door & dual airbags for 3-door, ensuring your safety.



HILL DESCENT CONTROL

Control your vehicle speed gracefully while descending steep roads.



HILL HOLD ASSIST

Prevent the vehicle from rolling backward when bravely facing a new peak.



BRAKE LIMITED SLIP DIFFERENTIAL TRACTION CONTROL

Experience quicker brake response with reduced pedal pressure and improved braking performance to prevent slipping on slippery surfaces.

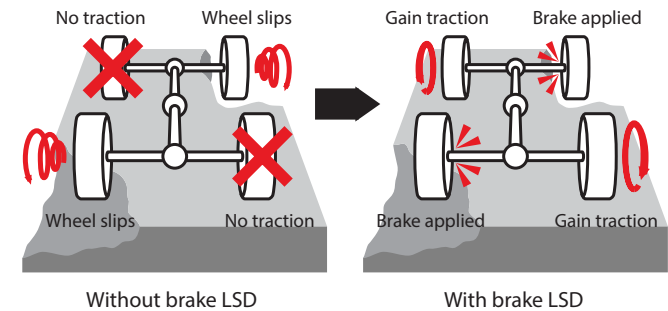



COLOR VARIANT

Jimny
5-door



NEW

METALLIC SIZZLING RED + PEARL BLUISH BLACK 4



KINETIC YELLOW 2 + PEARL BLUISH BLACK 4



METALLIC CHIFFON IVORY 2 + PEARL BLUISH BLACK 4



NEW

GRANITE GRAY METALLIC



PEARL BLUISH BLACK 4



JUNGLE GREEN 2

Jimny
3-door



KINETIC YELLOW + PEARL BLUISH BLACK 3



METALLIC BRISK BLUE + PEARL BLUISH BLACK 3



METALLIC CHIFFON IVORY + PEARL BLUISH BLACK 3



PEARL PURE WHITE



METALLIC SILKY SILVER



MEDIUM GRAY



PEARL BLUISH BLACK 3



JUNGLE GREEN

 **SUZUKI**

YOUR GEAR



UPGRADES TO THRIVE ANYWHERE

Explore all accessories that can enhance your Jimny 5-door's form and function.

CAMPING STYLE

1. ATTACHABLE TENT
2. MULTI ROOF RACK
3. ROOF BASKET
4. DOOR VISOR
5. DOOR HANDLE ESCUTHEON
6. SIDE UNDER GARNISH
7. MUD FLAP FRONT BLACK
8. MUD FLAP REAR BLACK
9. FRONT GRILLE JIMNY 3 DOORS
10. FRONT BUMPER UNDER GARNISH
11. FRONT DIFFERENTIAL GUARD
12. REAR DIFFERENTIAL GUARD
13. SPARE TIRE HALF COVER (SGP)
14. BRACKET SPARE TIRE HALF COVER (SGP)
15. DECAL FOR SPARE TIRE HALF COVER HONEYCOMB / RHINO
16. STICKER RHINO
17. LUGGAGE MAT
18. REAR GATE NET

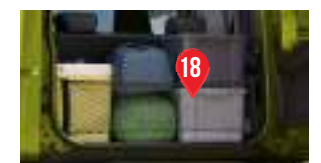
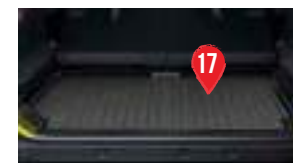
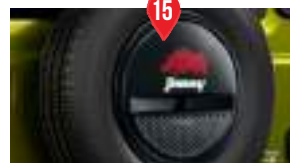
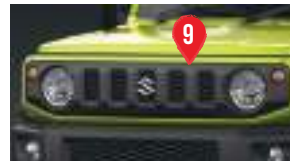



MARINE STYLE

1. DOOR VISOR
2. FRONT GRILLE (LOGO SUZUKI)
3. FRONT BUMPER UNDER GARNISH
4. SIDE UNDER GARNISH
5. MULTI ROOF RACK
6. SURFBOARD CARRIER
7. SPARE TIRE COVER, SOFT/RHINO
8. STICKER, RHINO
9. REAR GATE NET
10. LUGGAGE MAT

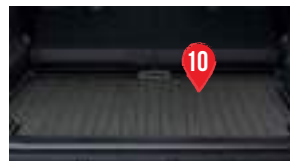
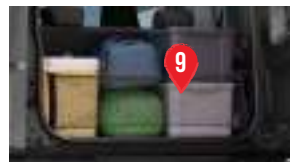
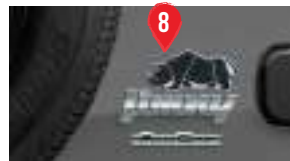

STREET STYLE

- | | |
|----------------------------|------------------------------------|
| 1. DOOR VISOR | 7. FRONT BUMPER UNDER GARNISH |
| 2. SIDE UNDER GARNISH | 8. AIR VENTILATION SATIN SILVER |
| 3. DOOR HANDLE GARNISH | 9. ASSISTANT GRIP COVER BROWN |
| 4. MULTI ROOF RACK | 10. DOOR INSIDE HANDLE COVER BROWN |
| 5. SPARE TIRE COVER, RIGID | 11. AT SHIFT PANEL SATIN SILVER |
| 6. DECAL, "JIMNY" | 12. FOOT ILLUMINATION LAMP |

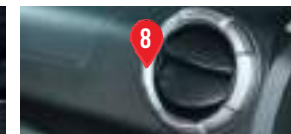

SCAN HERE
FOR FURTHER
ACCESSORIES INFORMATION



SPEKIFIKASI / SPECIFICATIONS

DIMENSI / DIMENSIONS		5-door	3-door
Panjang Keseluruhan / Overall Length	mm	3,965	3,650
Lebar Keseluruhan / Overall Width	mm	1,645	1,645
Tinggi Keseluruhan / Overall Height	mm	1,720	1,720
Jarak Poros Roda / Wheelbase	mm	2,590	2,250
Jarak Pijak Depan / Front Thread	mm	1,395	1,395
Jarak Pijak Belakang / Rear Thread	mm	1,405	1,405
Jarak Terendah / Ground Clearance	mm	210	210
Radius Putar Minimum / Minimum Turning Radius	m	5.7	4.85
KAPASITAS / CAPACITIES			
Tangki Bahan Bakar / Full tank Capacity	Litres	40	
MESIN / ENGINE			
Jenis / Type		K15B	
Silinder / Number of Cylinders		4	
Jumlah Katup / Number of Valves		16	
Isi Silinder / Piston Displacement	cm ³	1,462	
Diameter x Langkah / Bore x Stroke	mm	74.0 x 85.0	
Daya Maksimum / Maximum Output	PS/rpm	102/6,000	
Momen Puntir Maksimum / Maximum Torque	Nm/rpm	130/4,000	
Distribusi Bahan Bakar / Fuel Distribution		Multipoint Injection	

TRANSMISI / TRANSMISSION		MT	AT	
Perbandingan Gigi / Gear Ratio	1st	4.425	2.875	
	2nd	2.304	1.568	
	3rd	1.675	1.000	
	4th	1.190	0.697	
	5th	1.000	-	
	Reverse	5.152	2.300	
Perbandingan Gigi Akhir / Final Gear Ratio		4.091	4.300	
RANGKA / CHASSIS		5-door	3-door	
Sistem Kemudi / Steering		Recirculating Ball		
Suspensi / Suspension	Front	3-Link Rigid Axle with Coil Spring		
	Rear	3-Link Rigid Axle with Coil Spring		
Rem / Brakes	Front	Ventilated Disc	Solid Disc	
	Rear	Drum, Leading and Trailing		
Ukuran Ban / Tyres		195/80R15		
BERAT / WEIGHT		5-door	3-door	
Berat Kotor Kendaraan / Gross Vehicle Weight		Kg	1,545	1,435

Catatan:

Untuk peningkatan dan penyesuaian dengan perkembangan teknologi, spesifikasi ini sewaktu-waktu dapat berubah tanpa pemberitahuan terlebih dahulu.



PERLENGKAPAN / EQUIPMENTS

CHASSIS		5-door	3-door
Tyres and Wheels	195/80R15 + Alloy Wheels	●	●
Spare Tyre and Wheel	195/80R15 + Alloy Wheel	●	●
EXTERIOR			
Front Grille	Black with Chrome Accent	●	–
Wheel Arch Extensions	Material Colour	●	●
Drip Rails		●	●
Outside Door Handles	Body Coloured	●	●
Tailgate opener	Centre Door Lock	●	●
VISIBILITY			
Headlamps	LED Projector	●	●
Headlamp Leveling Device	Manual	●	●
Automatic Lamps		●	●
Lamp Washer		●	●
Fog Lamps	Front	●	●
DRL		●	●
Green Tinted Windows	Front Door Windows	●	●
	Quarter & Tailgate Windows	●	●
UV-Cut Glass	Windscreen	●	●
Wipers	Front: 2-Speed + Intermittent + Washer	●	●
	Tailgate: 1-Speed + Washer	●	●
Tailgate Window Demister		●	●
Outside Door Mirrors	Black (painted)	●	●
	Electrically Adjustable	●	●
	Electrically Foldable	●	●
STEERING AND INSTRUMENT PANEL			
3-Spoke Steering Wheel	Leathered Covered	●	●
	With Audio Controls	●	●
	With Cruise Controls	●	●
	With Hands-free Phone Control	●	●
	Tilt-Adjust	●	●
Power Steering		●	●
Tachometer		●	●
Light-off and Key Reminder	Alarm	●	●
Driver's Seatbelt Reminder	Lamp & Alarm	●	●
Passenger's Seatbelt Reminder	Lamp & Alarm	●	●
Rear Seatbelt Reminder	Lamp & Alarm	●	–
Door Ajar Reminder	Lamp	●	●
Low Fuel Warning	Lamp	●	●

DRIVING AMENITIES		5-door	3-door
Digital Clock		●	●
Electric Windows (Front)	Driver's Side (Up/Down Auto)	●	●
	Passenger's Side	●	●
Central Door Locking	Switch on Driver's Side	●	●
Remote-control Door Locks	With Hazard Lamp Answerback Function	●	●
Air Conditioner	Auto	●	●
Heater		●	●
Pollen Filter		●	●
Audio	Antenna (Mounted at Rear of Roof)	●	●
	Speaker x 2	●	●
	6.8" Display Audio + Bluetooth®**	–	●
	9" Display Audio + Bluetooth®**	●	–
	+ Rear View Camera	●	–
Cruise Control		●	●
INTERIOR			
Cabin Lights	Front Cabin Light (3-Position)	●	●
	Rear Cabin Light (3-Position)	●	●
Driver's Sun Visor	With Ticket Holder	●	●
	With Vanity Mirror	●	●
Passenger's Sun Visor	With Ticket Holder	●	●
	With Vanity Mirror	●	●
Assist Grips	Passenger's Side	●	●
	Rear x 2	●	●
Cup Holder	Front x 2	●	●
Shift Knob	Urethane	●	●
	With Chrome	● (MT)	● (MT)
	With Piano Black	● (AT)	● (AT)
Parking Brake Release Button	Chrome	●	●
12V Interior Accessory	Centre Console x 1	●	●
	Luggage Room x 1	●	●
USB Socket	Centre Console x 1	●	●
Remote Fuel Lid Opener		●	●
Inside Door Handles	Chrome	●	●
SEATS			
Front Seats	Walk-in Mechanism (Passenger's Side)	–	●
Rear Seats	50:50-split Single-folding	●	●
	Head Restraint x 2	●	●
Seat Upholstery Material	Fabric	●	●

SAFETY & SECURITY		5-door	3-door
SRS Front Dual Airbags		●	●
SRS Side Airbags	Front	●	–
Curtain Airbags		●	–
Seatbelts	Front: 3-point ELR Seatbelts x 2	●	●
	with Pretensioners and Force Limiters	●	●
	Rear: 3-point ELR Seatbelts x 2	●	●
	with Force Limiters	●	–
ISOFIX Child Seat Anchorages	Rear x 2	●	●
Pedal Release System	Brake & Clutch	●	●
Side Impact Door Beams		●	●
Parking Sensors	Rear	●	–
ABS		●	●
ESP®***		●	●
Hill Hold Control		●	●
Brake Assist Function		●	●
Shift Lock/Key Interlock		● (AT)	● (AT)
High-mount Stop Lamp		●	●
Immobilizer		●	●
Security Alarm		●	●

**Bluetooth® is a registered trademark of Bluetooth SIG, Inc.

***ESP® adalah merek dagang yang terdaftar untuk Daimler AG. ESP® didesain untuk membantu Suzuki Jimny agar mudah dikendalikan. Tetapi, efektivitasnya tergantung oleh kondisi berkendara dan keadaan permukaan jalan. Jika ban melewati limit cengkraman dan roda mulai berputar atau tergelincir, efektivitasnya mungkin akan berkurang.

Informasi lengkap kunjungi
<https://www.suzuki.co.id/automobile/jimny>

SCAN HERE
 FOR FURTHER
 PRODUCT INFORMATION





Cruise uncertainty confidently with the legacy.
In every turn and every acceleration, embrace the thrill of the journey.



JIMNY WHITE RHINO

- FRONT BUMPER UNDER GARNISH
- SIDE UNDER GARNISH
- DOOR VISOR
- DOOR HANDLE GARNISH CHROME
- SPARE TIRE COVER SOFT (RHINO)



9" TOUCHSCREEN HEAD UNIT
HD Resolution with Bluetooth™, USB, Smartphone Connection, Vehicle Status Display on Jimmy 5-door.



Works with **Apple CarPlay**
Connect your iPhone to the infotainment system wirelessly or via USB to enable hands-free telephone calls, listen to music, have texts read out, or dictate messages.



works with **androidauto**
Connect your device via a USB socket to access various applications from Google without losing your focus.



LADDER FRAME CHASSIS

Built with a robust Ladder Frame structure, the Jimny guides you through rugged topographies. Paired with full-width rigid axles at the front and rear, it conquers the most challenging paths.



ALLGRIP

Whether on smooth or challenging roads, simply shift the transfer lever. **2H**: For driving at normal speeds on roads (asphalt/gravel). **4H**: For off-road driving. **4L**: For navigating rough rocks, mud, and more challenging terrain.



3-LINK RIGID AXLE SUSPENSION WITH COIL SPRING

The Jimny, with its tough 3-link suspension and rigid axles at both the front and rear, ensures stability on any terrain. The rigid axle suspension pushes one wheel up while the axle presses the other down, especially in rough road conditions.



ENGINE PERFORMANCE

The responsive 1.5L K15B engine maintains off-road driving capability, producing strong torque throughout RPM range to provide unwavering power for conquering any terrain.

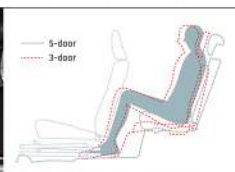

REAR SEAT POSITION

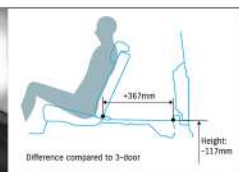

LUGGAGE AREA USABILITY



HILL DESCENT CONTROL
Control your vehicle speed gracefully while descending steep roads.



HILL HOLD ASSIST
Prevent the vehicle from rolling backward when bravely facing a new peak.

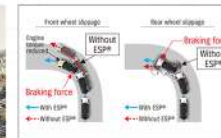

ESP (ELECTRONIC STABILITY PROGRAMME)**
Enhances braking stability on slippery and curved roads, preventing both oversteer and understeer.

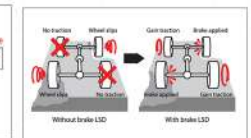

BRAKE LIMITED SLIP DIFFERENTIAL TRACTION CONTROL
Experience quicker brake response with reduced pedal pressure and improved braking performance to prevent slipping on slippery surfaces.



MANUAL LEVELING LED PROJECTOR HEADLAMP WITH WASHER



5 SLOTS CHROME GRILLE



REAR VIEW CAMERA



4 SPOTS PARKING SENSOR



AIRBAGS
Be extra prepared to navigate uncertainties with the six airbags for 5-door, ensuring your safety.



TECT BODY
The frame structure effectively absorbs and distributes energy during bumps and crashes, ensuring the cabin space remains more intact.